

USINAGE DES CHANTS

LES OPTIONS D'USINAGE DES CHANTS COMPRENNENT:

H-TG1

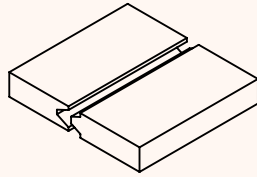
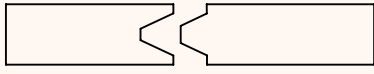

ASSEMBLAGE À MI-BOIS H-PS

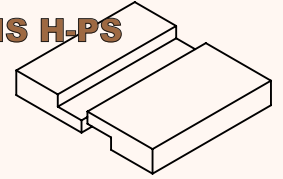
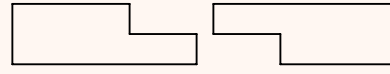

H-TG2

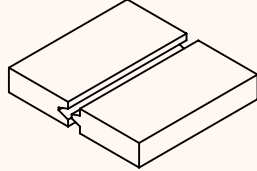
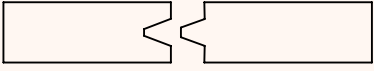

H-G

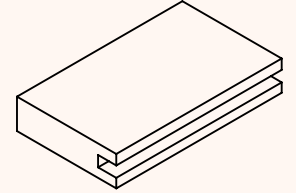
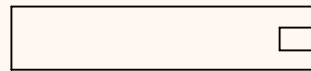

H-TG3

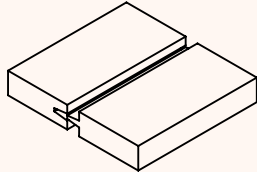
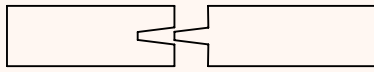

H-M4

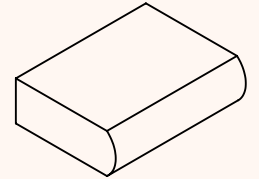
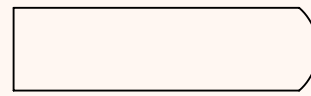

H-TG4

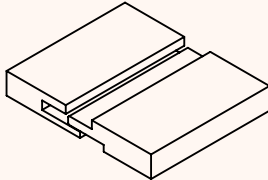
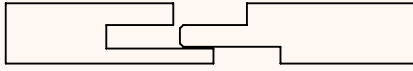

H-M11

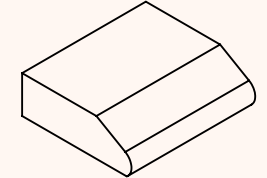
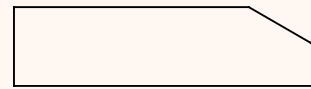

OPTIONS D'USINAGES DU CONTREPLAQUÉ



EXEMPLES DE PERÇAGES SUR MACHINE À COMMANDE NUMÉRIQUE

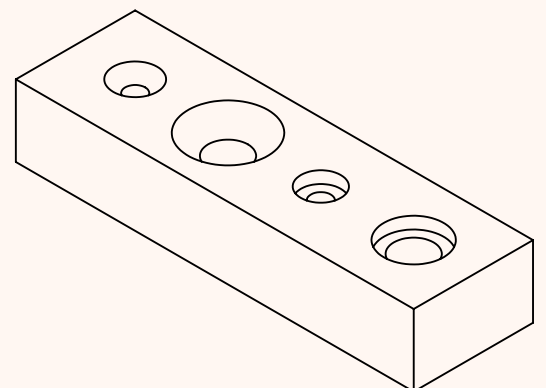
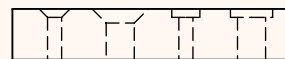
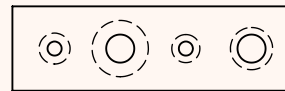

COMPOSANTS SPÉCIFIQUES

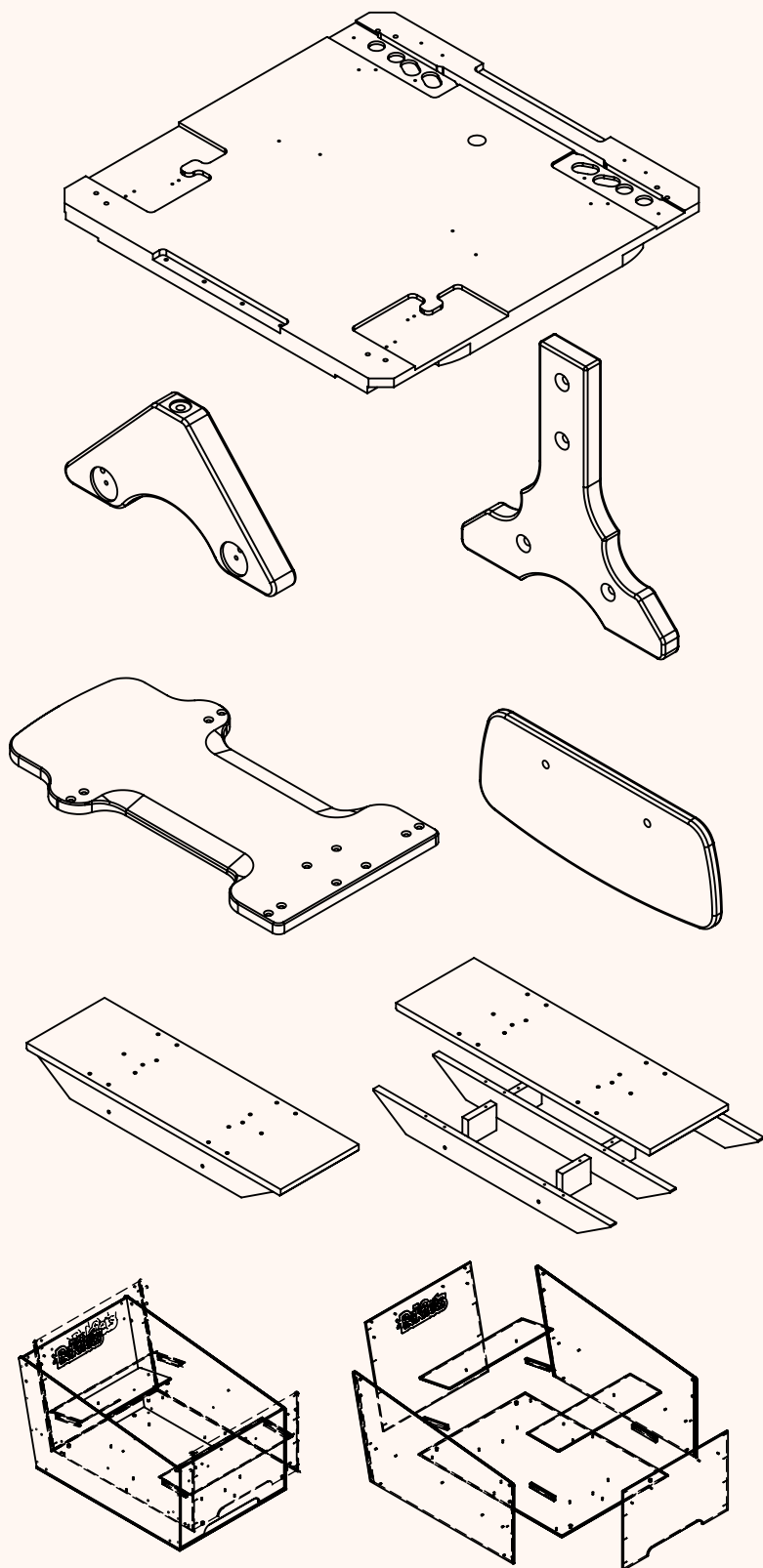

Le contreplaqué est fabriqué par *Latvijas Finieris AS*, dont le Système de Gestion de Qualité est homologué conformément aux exigences *ISO 9001* par le *Bureau Veritas Certification*.

ISO 9001

BUREAU VERITAS
Certification



The mark of responsible forestry
SW-COC-00519
©1996 Forest Stewardship Council A.C.

LATVIJAS FINIERIS

AKCIJU SABIEDRĪBA



Bauskas 59, Rīga, LV-1004, Lettonie
Tel. +371 67620857
Fax +371 67820112
E-mail: info@finieris.lv
<http://www.finieris.com>