

KANTENBEARBEITUNGEN

MÖGLICHE KANTENPROFILE:

H-TG1

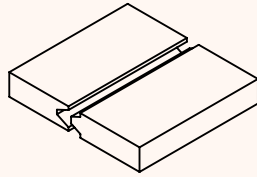
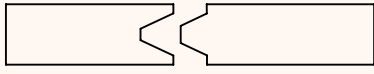

WECHSELFALZ H-PS

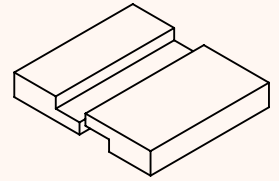
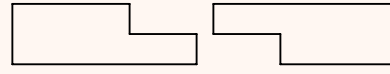

H-TG2

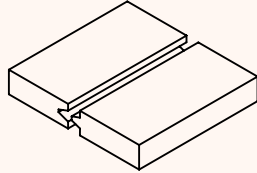
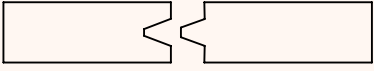

H-G

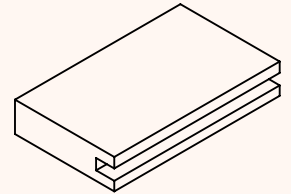
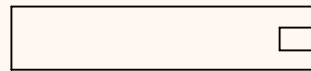

H-TG3

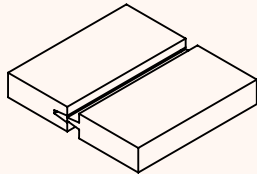
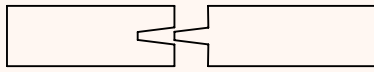

H-M4

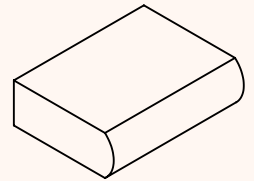
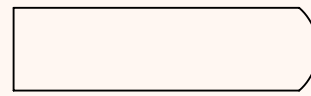

H-TG4

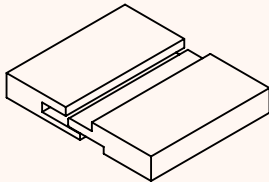
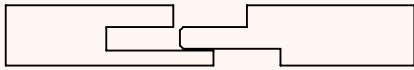

H-M11

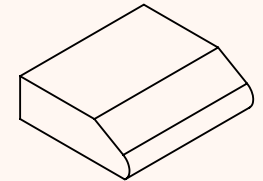
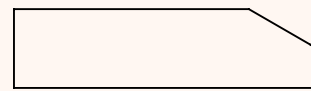

SPERRHOLZ BEARBEITUNGSMÖGLICHKEITEN



BEISPIELE FÜR BOHRUNGEN UND FRÄSUNGEN MIT CNC-ANLAGEN

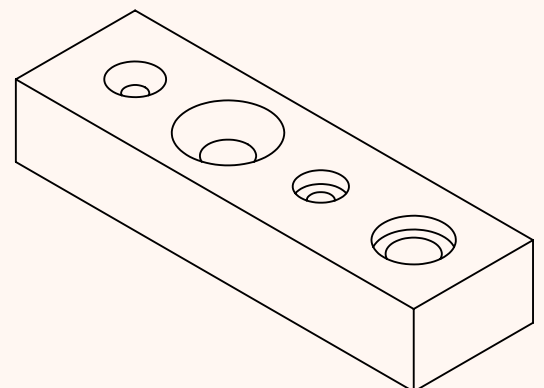
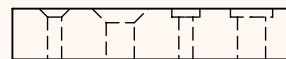

ANSPRUCHSVOLLE BAUTEILE

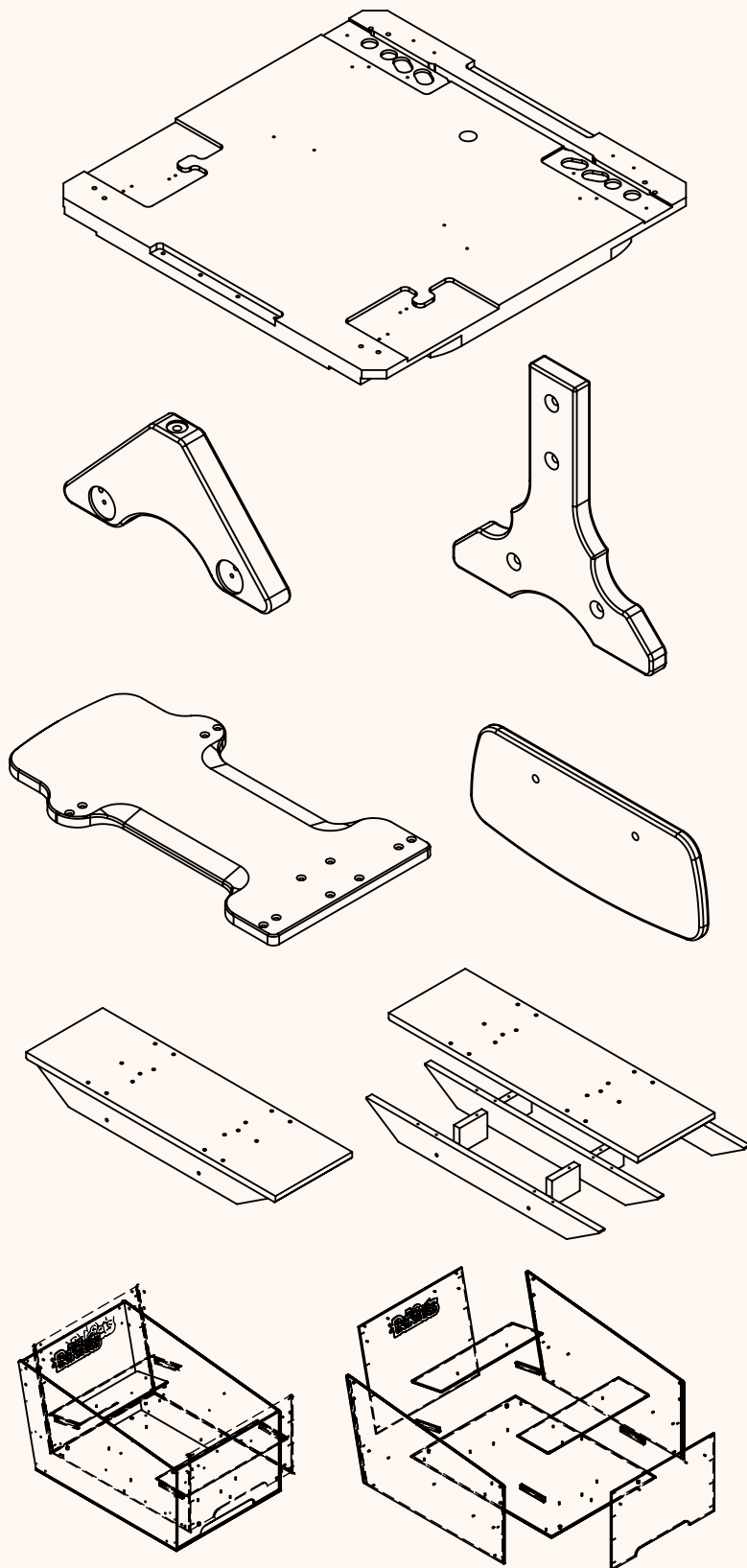

Das Sperrholz wird von der Aktiengesellschaft *Latvijas Finieris* produziert, deren Qualitäts-Management-System vom *Bureau Veritas Certification* nach *ISO 9001* zertifiziert worden ist.

ISO 9001
BUREAU VERITAS
Certification



LATVIJAS FINIERIS

AKCIJU SABIEDRĪBA



Bauskas 59, Rīga, LV-1004, Lettland
Tel. +371 67620857
Fax +371 67820112
E-mail: info@finieris.lv
<http://www.finieris.com>

Diese Informationen dienen als Auskunft. Weiterhin behält sich *Latvijas Finieris AS* vor, Ergänzungen und/oder Änderungen einzelner Produkte ohne vorherige Ankündigung vorzunehmen.

Nr. 031_301_211108